



CUSTOM

SC ICE CREAM CABINET MODEL 69000

Self-contained ice cream storage and dipping cabinet with R-404a cooling system. 16 gauge stainless steel top, and integral backsplash with 45° return. Die-stamped openings in top with insulated lids. Stainless steel fronts, stainless steel interior with welded-in-place refrigeration lines. 6" high adjustable and movable legs.

AVAILABLE MODELS:

- 69345
- 69357

STANDARD FEATURES:

- Refrigeration system features "CFC free" R-404a refrigerant, expansion valve for fast recovery and even temperature regulation
- Superb low temperature unit for ice cream storage and dipping
- Stainless steel interior allows double stacking of standard 3 gallon containers
- Foamed in place "CFC free" urethane insulation
- Sink and dipper well available
- 6" high legs—adjustable and movable
- 45° integral stainless backsplash is standard. 90° stainless backsplash is optional.

CABINET EXTERIOR: Top to be one piece of die formed 16 gauge stainless steel with 2 5/8" nosing. Backsplash to be coved cornered, with 45° return at top and overall height of 6 3/4". Ends at top fitted with recessed heavy duty steel bars for field bolting units together, producing a hairline seam. Top to have die stamped cut-outs with raised rims, fitted with removable, hinged, insulated lids. Exterior body to be corrosion resistant steel. Front panels to be removable, constructed of 22 gauge die-stamped stainless steel. Louver panel to be die-stamped stainless steel. Work surface to be at 36" work height. Legs to be 6" high stainless steel with adjustable bullet foot. Legs mounted to full length channel frame assembly which is integrally welded to bottom of body assembly. Legs can be moved left to right to avoid floor obstacles during installation.

CABINET INTERIOR: Unit interior to be stainless steel, with interior sides to be wrapped with refrigerating lines held firmly in place with holding clips welded to unit body. Unit insulation to be CFC free foamed in place urethane.

REFRIGERATION: Cooling system to utilize R-404a refrigerant. Expansion valve fitted to refrigeration line with pressure control installed for temperature control. Condensing unit sized and installed for proper cooling in housing at right end. Unit totally prewired and to be supplied with 8' cordset (NEMA 5-15P) for 115V operation.

ORIGIN OF MANUFACTURE: Designed and manufactured in the United States.

PROJECT NAME:

LOCATION:

ITEM NO:

QTY:

MODEL NO:

AIA NO:

SIS NO:

CSI SECTION: 11400

SC Ice Cream Cabinet. Model shown with optional finished end, sink and dipperwell.



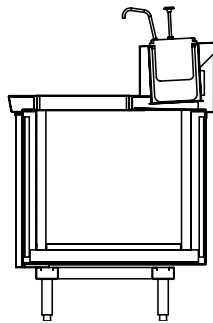
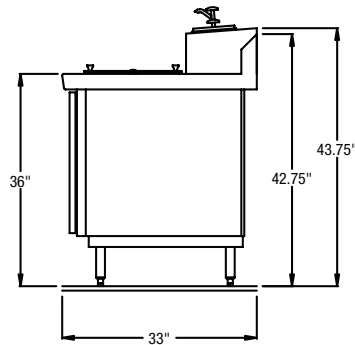
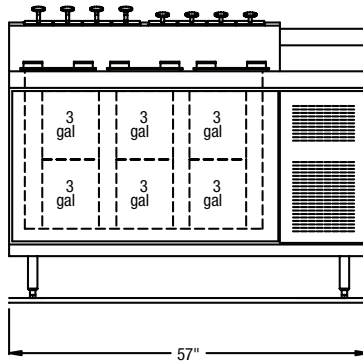
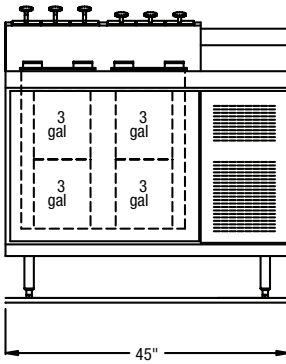
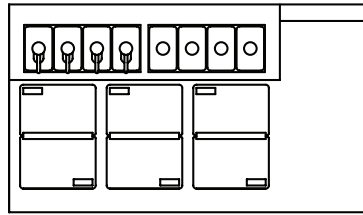
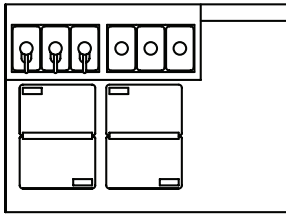

SECTION VIEW

LEGEND

AFF = ABOVE FIXED FLOOR

HP HP COMPRESSOR
JUNCTION BOX 26" AFF
115V/60Hz/1Ph
8' LONG CORD SET
(NEMA 5-15P)

OC CONDENSATE DRAIN 1/2"
PVC 10" AFF.

V EXPANSION VALVE
20 AFF.

EXPANSION VALVE
MTD. BELOW J-BOX

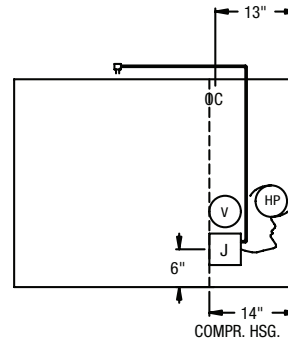

Model	L	L	H	Storage Capacity	HP	Volt	Amps	NEMA	Ship Wt.
69345	45"	29"	36"	24 gal.	1/3	115/60/1	6.5	5-15P	418
69357	57"	29"	36"	36 gal.	1/3	115/60/1	6.5	5-15P	458
69345	45"	33"	36"	24 gal.	1/3	115/60/1	6.5	5-15P	418
69357	57"	33"	36"	36 gal.	1/3	115/60/1	6.5	5-15P	458

Standard Equipment in a 31" Rail
 (3) Syrup Pumps
 (3) Fruit Jars with ladles

Standard Equipment in a 43" Rail
 (4) Syrup Pumps
 (4) fruit Jars with ladles

* All units on 6" high adjustable, movable legs for 35 1/2" to 36 3/4" high work surface. Designed for 7" ice cream, 45° rail temperature.