



SILVER SOAK

CONTINUOUS MOTION DROP-IN PRE-WASHING SYSTEM MODEL SS-D

The Silver Soak is a continuous motion pre-washing system that eliminates multiple washing of silverware. Washes in a flat rack through a dishmachine before sorting it and running it through the dishmachine for one pass warewashing. The elimination of multiple washes reduces labor, water, ventilation and chemical costs while delivering consistent results that will make an excellent first impression for all of your customers.

SHORT FORM SPEC: Silver Soak Sink, drop-in, 26.4" H, 11 gallon wash tank, 304 stainless steel, 14 gauge tank and rim, 3/4 HP, 115V, 208V, or 230V, 60/1-PH, NSF, UL.

STANDARD SPECIFICATIONS:

- 304 stainless steel construction with 14 gauge tank, legs, and rim
- System conforms to ANSI/NSF Standard 2 with all welds to be heliarc (TIG) welds
- Wash tank shall be 15.4" square with stainless steel collar
- Stainless steel collar 18.68" square
- Wash tank to be dropped into stainless steel tabling using the stainless steel collar to secure the tabling
- 11 gallon wash tank capacity
- ¾ HP wash pump motor
- Wash pump to recirculate wash water at 600 gallons per minute flow rate
- Wash tank temperature to maintain 114 degrees when filled with warm water and running with no wash tank heater
- Stainless steel removable drain screen
- (2) stainless steel silverware baskets included
- Silver Soak holds one silverware basket when operating
- Silverware basket holds approximately 250 pieces of silverware
- Single drain included
- Uses standard pre-soak chemical
- Will de-tarnish silver plate with proper presoak chemical and aluminum bar (bar by others)

CONTROLS:

- PS-50: Single Pistol grip On/Off mechanical Start/Stop
- Meets UL 50, category 4X specifications
 - Mounting bracket and mounting studs for control panel included (enables easy mounting of control panel to wall, dish table or wash tank)

ELECTRICAL CONNECTION OPTIONS:

- 115V/60/1, 8.4 Amps
- 208V/60/1, 4.8 Amps
- 230V/60/1, 5.2 Amps

PLUMBING:

- ½" single handle faucet "hot only" included
- 1-½" inside diameter ball valve drain provided

WARRANTY:

Three years parts and labor warranty



PROJECT NAME:	
LOCATION:	
ITEM NO:	
QTY:	
MODEL NO:	
AIA NO:	
SIS NO:	
CSI SECTION:	11400



OPTIONAL ACCESSORIES:

- Additional silverware baskets
- Splash guard

ADDITIONAL RESOURCES:

- [Request A Quote](#)
- [Sales Tools](#)
- [Find A Rep](#)

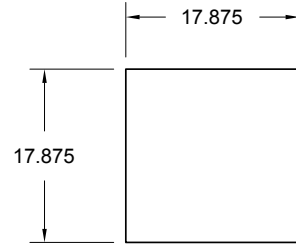
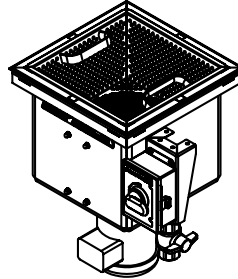
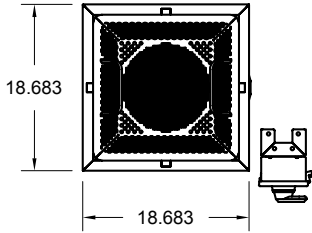
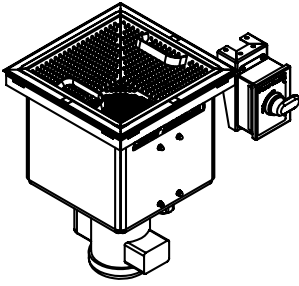
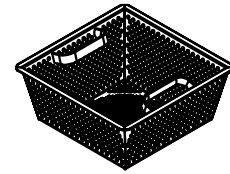
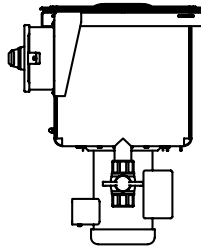
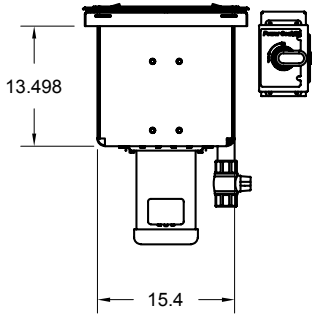
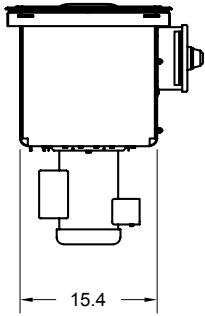
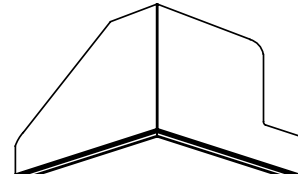

TABLE CUT OUT DIMENSIONS



(2) REMOVABLE WASH TANK BASKETS INCLUDED



OPTIONAL SPLASH GUARD