



HOT FOOD TABLE

ELECTRIC EXPOSED ELEMENT WELL MODEL 3500

Electric operated, stainless steel open shelving base hot food table with 20 gauge stainless steel top, and individual die-stamped 12" x 20" top openings. Individual thermostatically controlled, electrically heated, open food wells (spillage pans required for wet operation). Unit totally prewired to junction box, power cord is supplied. 7" wide plate shelf & 8" wide NSF workboard. Unit on 6" high adjustable legs.

PROJECT NAME:

LOCATION:

ITEM NO:

QTY:

MODEL NO:

AIA NO:

SIS NO:

CSI SECTION: 11400

AVAILABLE MODELS:

- 3512
- 3513
- 3514
- 3515

STANDARD FEATURES:

- Die stamped raised sanitary rim pan openings in stainless steel top
- Stainless steel body construction - no assembly required
- Thermostatic control for precise food temperatures - one per well
- Stainless steel, full length plate shelf - 7" deep
- Stainless steel ends
- Full length, 8" wide NSF workboard
- 6" high adjustable legs
- Power cord
- Available for 120V, 208V, or 240 volt operation

UNIT TOP: Top to be one piece of die formed 20 gauge stainless steel with 1 5/8" square nosing. Top stamped with individual 12"x 20" die formed raised perimeter openings. Unit fitted with compliment of electrically heated, open food wells, individual thermostatically controlled. Spillage pans required for wet operation. Provided with 7" deep, removable 20 gauge stainless steel plate shelf, and 8" wide x 1/2" thick, full length NSF composition workboard.

FOOD WELLS: 12"x 20" electrically heated, open food wells, individually and thermostatically controlled.

CONTROLS: Unit comes standard with thermostatic controls. Each controls has a lighted on/off switch that allows turning off of each control independently. Controls and elements mounted on front of 7" deep removable stainless steel plate shelf. Connections to heating elements are located outside of heated zone to avoid wiring deterioration. Individual food wells wired to common junction box(es). Power cord is supplied.

UNIT BASE: Bottom shelf to be stainless steel with channel bracing. Body ends to be stainless steel. Legs to be 6" high with adjustable bullet foot. Legs mounted to full length channel frame assembly on bottom of body assembly.

ORIGIN OF MANUFACTURE: Designed and manufactured in the United States.

3500 Electric Exposed Element Wells, Model 3513 with optional casters shown.



OPTIONS/ACCESSORIES:

- Counter Protectors
- Serving Shelves/Plexi Shields
- Overshelves
- Casters
- Roll Covers
- Adaptor Plates
- Spillage Pans
- Stainless Steel Back
- Voltage Other than Standard
On 3-5 Well Only (cord & plug not supplied as standard with 3 phase)

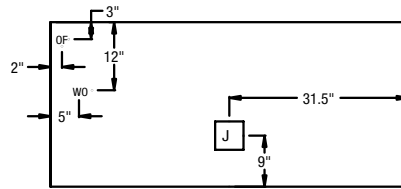
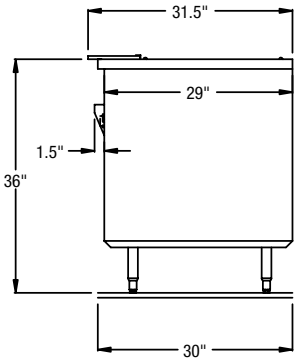
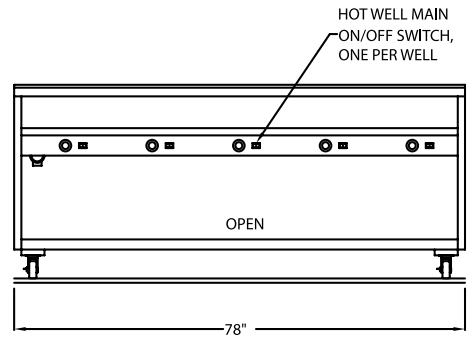
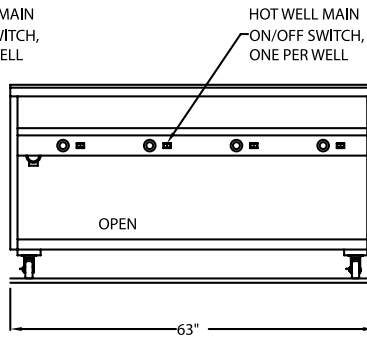
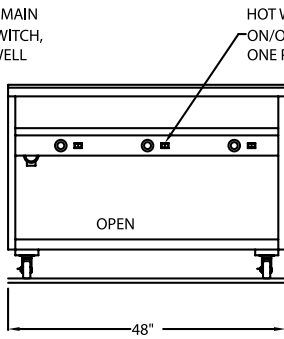
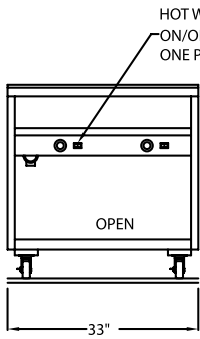
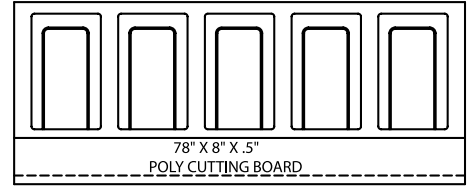
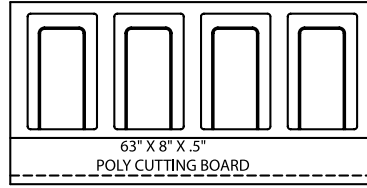
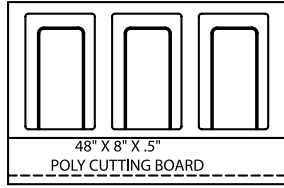
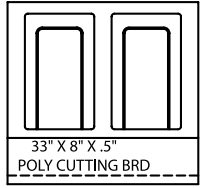

Model	L	D	H	No. of wells	No. of elements	Bottom Shelf Material	Sq. Ft.	120V-750Watt			208V-865Watt			240V-1150Watt			Ship Wt.
								KW	Amps	NEMA	KW	Amps	NEMA	KW	Amps	NEMA	
3512	33"	30"	36"	2	2	S.S.	5.5	1.50	12.50	5-20P	1.73	8.32	6-15P	2.30	9.58	6-15P	116
3513	48"	30"	36"	3	3	S.S.	8.1	2.25	18.75	5-30P	2.60	12.48	6-20P	3.45	14.38	6-20P	174
3514	63"	30"	36"	4	4	S.S.	10.7	3.00	25.00	5-50P	3.46	16.63	6-30P	4.60	19.17	6-30P	232
3515	78"	30"	36"	5	5	S.S.	13.3	3.75	31.25	5-50P	4.33	20.79	6-30P	5.75	23.96	6-30P	290