



POWER PREP

INTRO FREE FLOWING WASH ACTION 3-BAY MODELS PPI3B-75L/R

The Power Prep provides patented, free flowing wash action, reaching hard to reach areas on produce in a 3-bay configuration. NSF approved for washing whole, uncut, unpeeled fruits and vegetables.



PROJECT NAME:	
LOCATION:	
ITEM NO:	
QTY:	
MODEL NO:	
AIA NO:	
SIS NO:	
CSI SECTION:	11400

AVAILABLE MODELS:

- PPI3B-75L-115-1 PPI3B-75R-115-1
- PPI3B-75L-208-1 PPI3B-75R-208-1
- PPI3B-75L-230-1 PPI3B-75R-230-1

STANDARD SPECIFICATIONS:

- Left to right (L) or right to left (R) configurations
- Hemmed end splash
- 18" Solid drain board
- 30" Clean drain board
- 1-1/2" Ball drain valve
- Patented wash flow design allows for washed produce to be automatically collected into the stainless steel unloading baskets
- 3-bay wash tanks include 1 unload basket
- Custom configurations available, including tabling, shelving, and accessories
- Low profile wash jets average every 3 inches along the back wall of wash tank above the wash tank intake – wash jets provide free flowing uniform wash action
- Wash tank to have ultra-high molecular weight polyethylene (UHMW) flexible tank dividers, (UHMW) wash tank bay flow guides, high density polyethylene (HDPE) rib system integrally connected with stainless steel rods
- Stainless steel self – draining pump housing and impeller, all wetted parts of the pump assembly are stainless steel
- Wash Tanks supported by 1-5/8" stainless diameter legs with 1-1/4" stainless cross members and adjustable stainless steel bullet feet
- Type 304 stainless steel construction throughout tanks, drain boards, splashes and channel rims (14 gauge)
- High quality 1/2" faucet assembly with pre-rinse spray

- Rear-exit stainless ball valve drain for 100% drainage
- 3/4 HP heavy duty (TEFC) wash pump motors (high service factor) are provided with all stainless steel pump assemblies
- Modular design allows quick and easy access to: motor, pump and all major components
- 208/230V, 1-phase, 5.2/4.8 Amps or 115V, 1-phase, 8.4 Amps
- Flow guides

CONTROLS:

PS-50: Pistol Grip ON/OFF mechanical Start/Stop switch

WARRANTY:

- Three year parts and three year labor warranty from the date of shipping (USA only)
- One year flow guide warranty

ORIGIN OF MANUFACTURE:

Designed and manufactured in the United States.



OPTIONAL ACCESSORIES:

- Stainless steel backsplash extensions
- Unload baskets
- Strainer for unload basket
- Over and under shelves

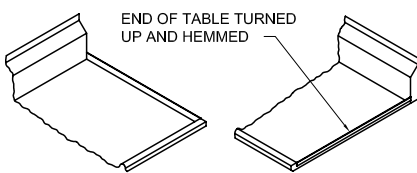
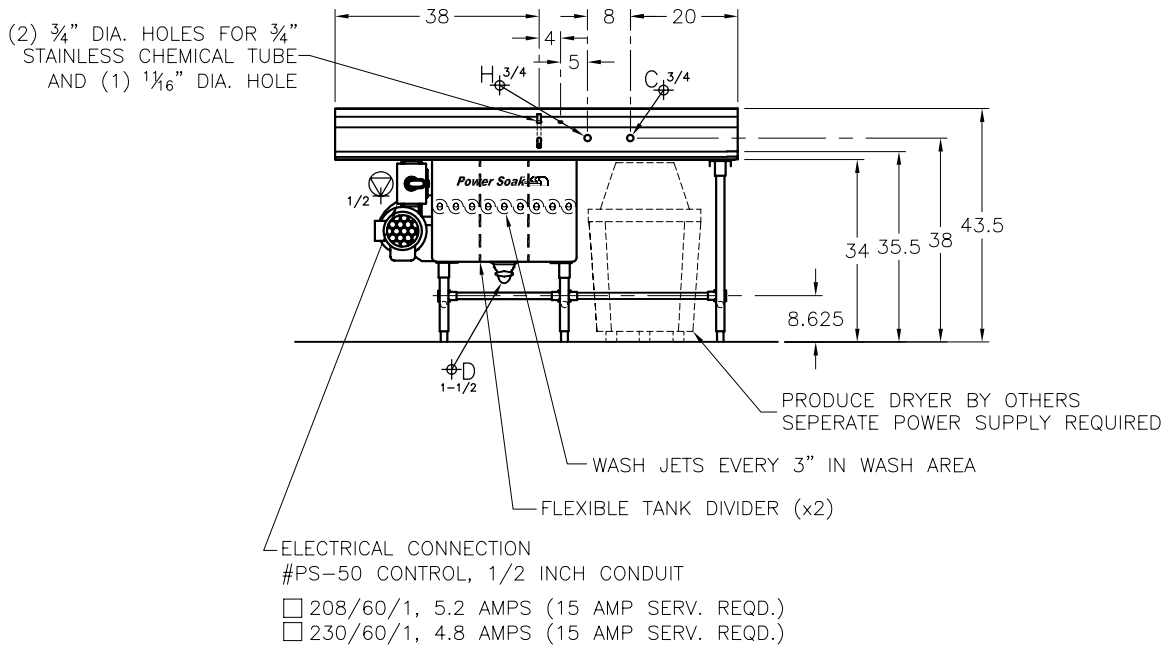
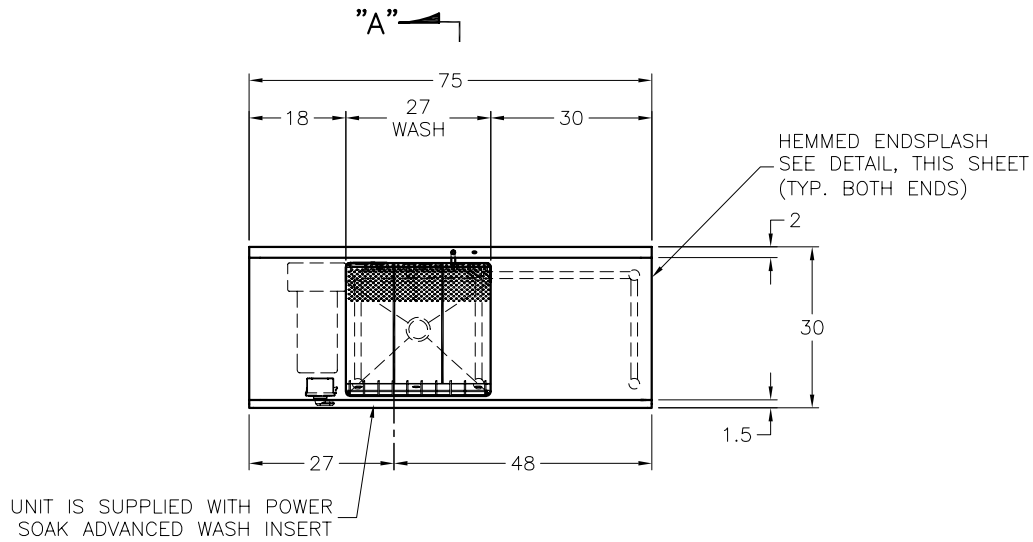

HEMMED ENDSPLASH DETAIL

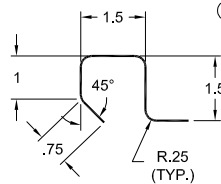

SQ. CHANNEL RIM DETAIL

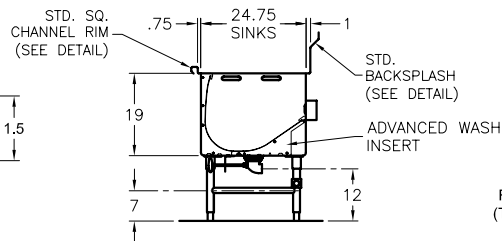

SECTION "A"

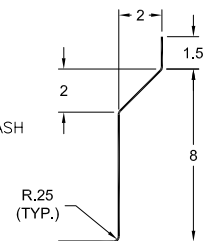

BACKSPLASH DETAIL