



CUSTOM

SC REFRIGERATED STORAGE MODEL 51000LPPO

Self-Contained drawer base refrigerator storage units with mechanically cooled pan opening. These units are offered in variety of lengths to meet your specific base storage or pan storage requirements. The mechanically cooled pan opening uses Randell's exclusive design technologies, such as our Exclusive Refrigerated Pan Opening Thermostat allowing customers to make adjustments to the opening temperatures (independent of the base). Automatic hot gas evaporator is provided for eliminating the base coil's condensation. The base is designed with a "low-profile" cabinet and is supplied with a plate shelf above the refrigerated openings. These units feature our Patented Drawer Cartridge Assembly. A fully welded, unitized drawer cartridge assembly with a quick release that allows the refrigerated drawers to be easily removed for cleaning

PROJECT NAME:

LOCATION:

ITEM NO:

QTY:

MODEL NO:

AIA NO:

SIS NO:

CSI SECTION: 11400

AVAILABLE MODELS:

- 51342LPPO
- 51350LPPO
- 51355LPPO
- 51367LPPO
- 51372LLPO
- 51375LPPO
- 51380LPPO
- 51385LPPO
- 51397LPPO

STANDARD FEATURES:

- "Low-profile" refrigerated cabinet with plate shelf above
- Low profile 2" recess pan design provides easy reach and optimal pan temperatures & reliability
- Balanced (extra) high capacity refrigeration system with expansion valve metering-able to handle peak period demands
- Full Length Poly Cutting Board
- Front breathing compressor housing with directed air flow-Randell Exclusive
- Patented Drawer Cartridge System with easy maintenance Press-Fit gaskets - A Randell Exclusive
- Pan opening thermostat- A Randell Exclusive
- Drain in pan opening for easy cleaning
- Hinged louver for easy access
- Hinged removable stainless steel covers
- Automatic base defrost with condensate evaporator
- Foamed in place urethane insulation providing superior insulation and durability
- 6" high adjustable legs, moveable left to right if needed
- Available up to 16' under one common assembly
- Adapter bars are standard to accommodate a compliment of 1/6 size pans
- Front breathing louver design allows sealing to wall & curb mounting without special requirements

CABINET EXTERIOR: Top to be one piece of die formed 16 gauge stainless steel with 2 1/2" nosing. Backsplash to be coved cornered, with 45° return at

top and overall height of 6 3/4". Ends at top fitted with recessed heavy duty steel bars for field bolting units together, producing a hairline seam. Hinged louver panel to be stainless steel. Exterior body to be corrosion resistant steel. Door opening frames are ABS and contain magnetic strip for positive seal of door gaskets. Work surface to be at 36" work height. Legs to be 6" high stainless steel with adjustable bullet foot. Legs mounted to full length channel frame assembly which is integrally welded to bottom of body assembly. Legs can be moved left to right to avoid floor obstacles during installation.

CABINET INTERIOR: Base interior to be ABS thermoplastic at ends only. Stainless steel interior liner to be coved cornered to form bottom, back and top. One baked enamel finished shelf provided behind each door. Unit insulation to be CFC free foamed in place urethane.

REFRIGERATED DRAWERS: Fully welded, unitized drawer cartridge assembly - patented. Heavy duty full extension 14 gauge drawer tracks on 1 5/8" heavy duty stainless steel bearings. Will accommodate (2) 12" x 20" x 4" deep pans per drawer (pans not included). Quick release allows drawers to be easily removed for cleaning. Stainless fronts, mounted to drawer cartridge assembly with easy to grasp drawer handles. Drawers are self-closing with press fit magnetic gaskets - (designed for installation & removal without tools).

REFRIGERATION: System is a balanced heavy duty R-404A refrigerant system with an energy efficient automatic defrost (for base evaporator coil). The base is cooled by an independent blower coiled operating on its own expansion valve and thermostat and operates through a dedicated solenoid valve. A pressure control is provided to operate the condensing unit on demand. The pan opening is provided with its own thermostat (located in the compressor housing) making it easily adjustable for specific ambient conditions without effecting the balance of the system. An on/off switch for the pan opening is located above the louver panel.

ORIGIN OF MANUFACTURE: Designed and manufactured in the United States.

SC Refrigerated Storage. Model 51375LPPO shown with optional finished end.



OPTIONS/ACCESSORIES:

- Hinged slide back cover
- Lift-off (removable) night covers
- Stainless Steel Ends
- Stainless Steel Back
- Laminate fronts, ends and back options
- Casters in lieu of legs
- Wide pan opening

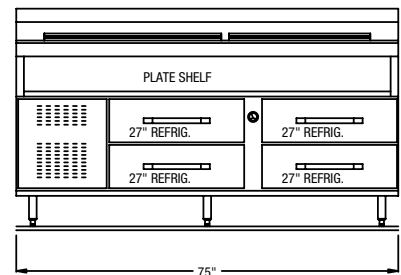
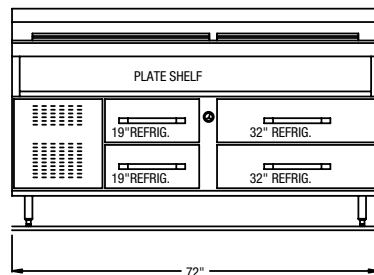
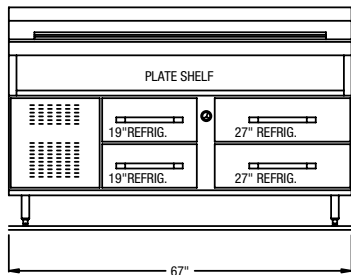
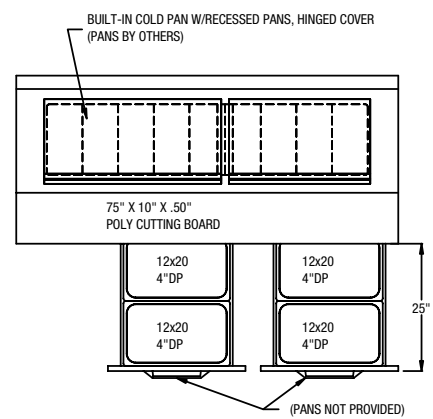
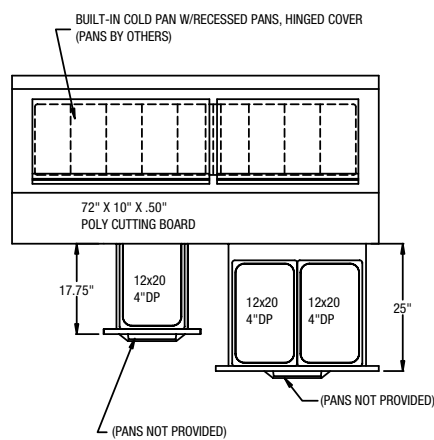
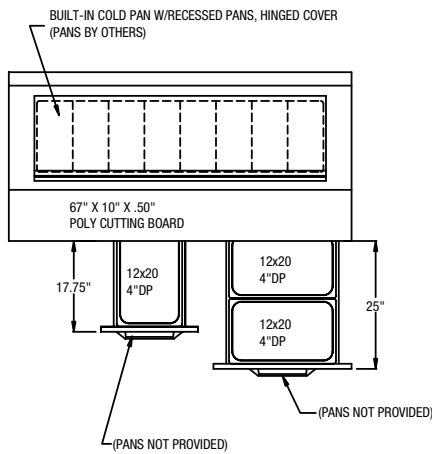
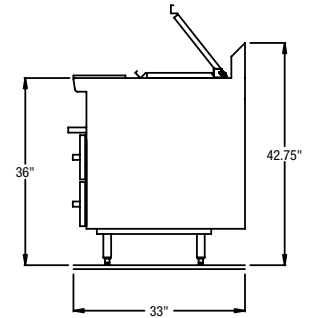
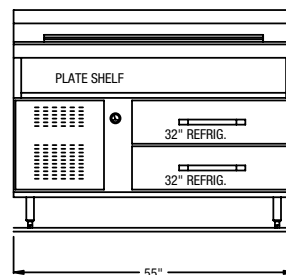
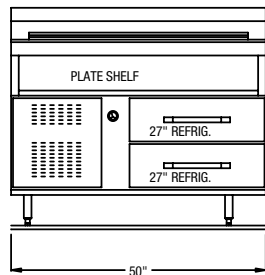
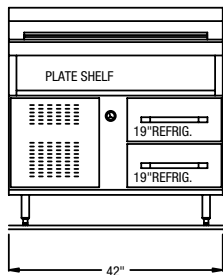
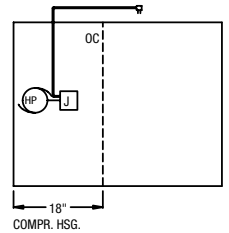
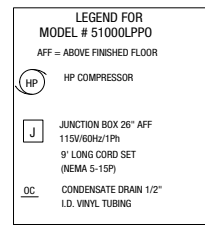
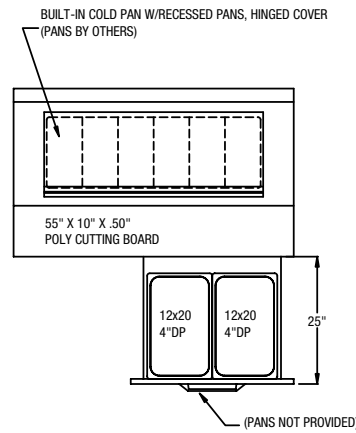
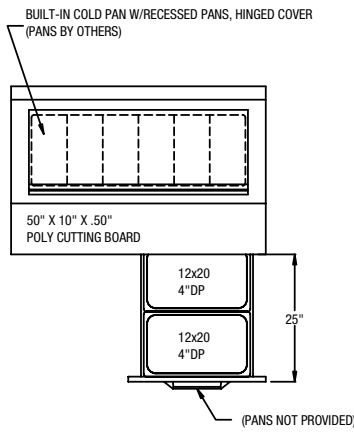
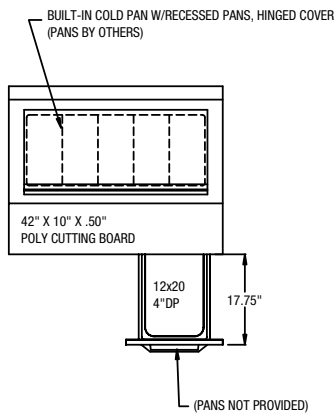

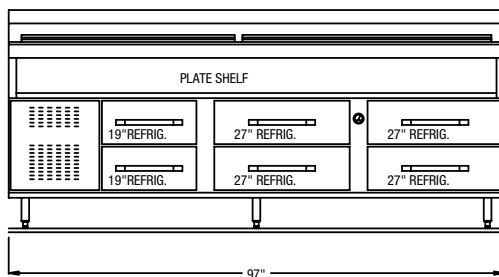
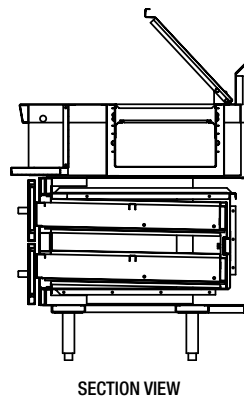
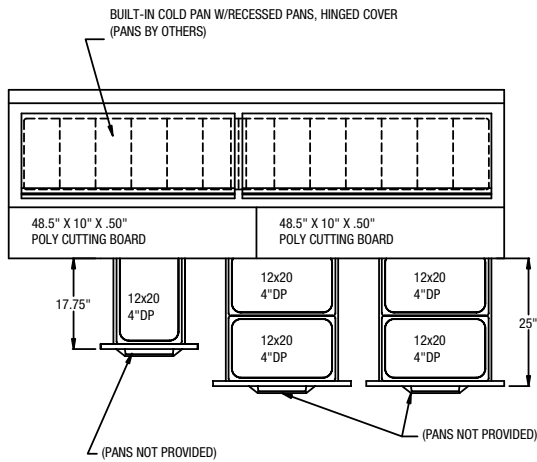
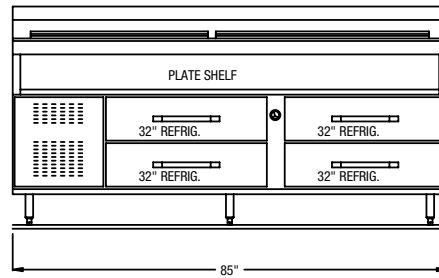
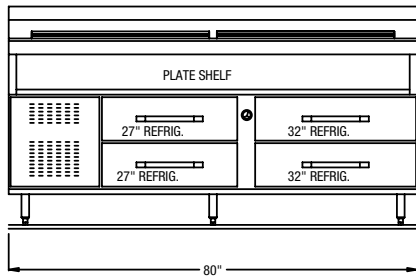
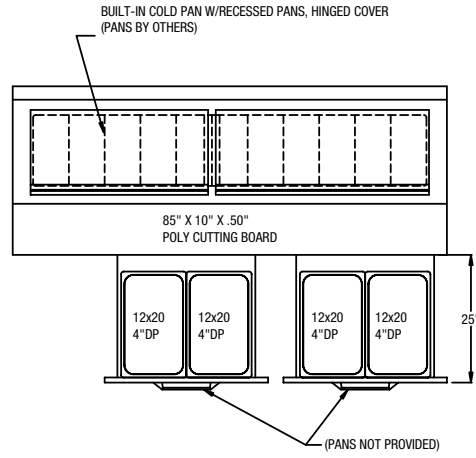
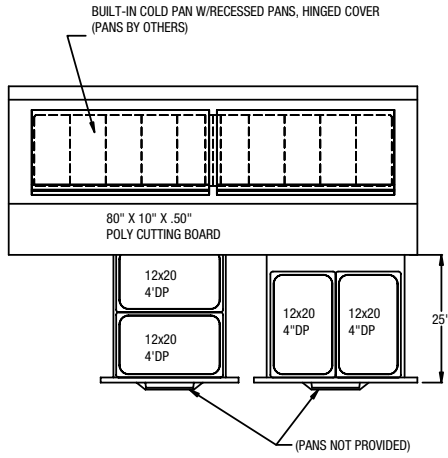



51000LPP0 SERIES (COMPRESSOR LEFT) SELF-CONTAINED DRAWER BASE REFRIGERATORS WITH STANDARD DEPTH RECESSED PAN OPENING									
Length	42"	50"	55"	67"	72"	75"	80"	85"	97"
Model 33" deep	51342LPP0	51350LPP0	51355LPP0	51367LPP0	51372LPP0	51375LPP0	51380LPP0	51385LPP0	51397LPP0
#of sets of drawers	(1) set 19" +5" mullion	(1) set 27" +5" mullion	(1) set 32" +5" mullion	(1) set 19" (1) set 27" +3" mullion	(1) set 19" (1) set 32" +3" mullion	(2) sets 27" +3" mullion	(1) set 27" (1) set 32"	(2) sets 32" +3 mullion	(1) set 19" (2) sets 27" +(2) 3" mullion
Total# of 12x12 pans in drawer*	(2)12x20's	(4) 12x20's	(4) 12x20's	(6) 12x20's	(6) 12x20's	(8) 12x20's	(8) 12x20's	(8) 12x20's	(10) 12x20's
Min. Compr. Hsg.	18"	18"	18"	18"	18"	18"	18"	18"	18"
Min. # Pans	(6) 1/6	(6) 1/6	(6) 1/6	(6) 1/6	(8) 1/6	(6) 1/6	(10) 1/6	(10) 1/6	(10) 1/6
Min. Length (clear) of Opening	27"	27"	27"	27"	34"	41"	41"	41"	41"
Max. # Pans	(10) 1/6	(12) 1/6	(12) 1/6	(16) 1/6	(16) 1/6	(16) 1/6	(18) 1/6	(20) 1/6	(24) 1/6
Cutting Board Width	10" wide	10" wide	10" wide	10" wide	10" wide	10" wide	10" wide	10" wide	10" wide
H.P./Refrigerant	1/3hp/R404	1/3hp/R404	1/3hp/R404	1/3hp/R404	1/2hp/R404	1/2hp/R404	1/2hp/R404	1/2hp/R404	1/2hp/R404
Volt/Cycle/Phase	115/60/1	115/60/1	115/60/1	115/60/1	115/60/1	115/60/1	115/60/1	115/60/1	115/60/1
Amps	9.0	9.0	9.0	9.0	12.0	12.0	12.0	12.0	12.0
NEMA	5-15P	5-15P	5-15P	5-15P	5-15P	5-15P	5-15P	5-15P	5-15P
Ship Wt.- lbs	460	496	545	617	672	687	708	726	844
BTU Design load opening (-10)/Base(+20)	294/267	353/337	412/381	529/552	529/596	588/622	588/666	647/710	764/881
BTU Design load opening/base	1109/2141	1201/2141	1283/2141	1423/2141	1759/3319	1866/3319	1866/3319	1966/3319	2151/3319

NOTE: Pan capacity reflected is the actual amount of pans that are clearly accessible by the operator. Units with multiple covers may actually have additional pan capacity that is partially obstructed by the cover divider/mullion.

BTU based on 86F ambient.

*Pans not provided.