



PREP STATIONS

SPECIALTY CUSTOM FLAT CONDIMENT NARROW RAIL MODELS LPNPO

Self-contained "low profile" drawer base refrigerator storage unit with plate shelf above the drawers and a mechanically cooled pan opening. Cold-wall conductive cooled pan opening with recessed pan ledge provides easy reach and cold above pans for optimal temperatures. Separate base and pan opening controllers give the operator precise control of the temperature in each zone and the ability to shut the pan opening off at night-conserves up to 60% of the daytime energy usage. Standard clean-out port valve allows pan opening to be easily cleaned and sanitized.

SHORT FORM SPEC: Randell LPNPO series preparation table with natural R290 refrigeration system. Includes independently controlled mechanically cooled pan opening and refrigerated base, each controlled by their own electronic control. Single pan opening to come standard with recessed pan ledge, adapter bars and oversized clean-out port for ease of cleanability. Base interior ends and drawer openings shall be high impact ABS plastic and be cooled with a blower coil located behind the mullion. Base cabinet standard with plate shelf and cartridge style drawers with included press-fit magnetic gaskets. Unit to be shipped standard on adjustable legs mounted to full length leg rails.

AVAILABLE MODELS:

1 Section:	2 Sections:
LPNPOx133	LPNPOx249
LPNPOx138	LPNPOx254
LPNPOx150	LPNPOx257

STANDARD FEATURES:

- Low profile refrigerated cabinet with plate storage shelf
- Cold-wall conductive cooled pan opening with recessed pan ledge for easy reach and cold above pans
- Base cooled by high capacity mullion coil refrigeration system with adaptive defrost
- Visible externally mounted electronic controllers to monitor pan opening and base settings
- Independent temp control for pan opening and base allows precise temperature maintenance in each zone
- 100% front breathing compressor housing allows sealing to wall and curb mounting without special requirements
- Drawer cartridge system with easy maintenance press-fit gaskets (removable without tools)
- Exclusive completely sealed pan opening interior with clean-out port allows pan opening to be easily cleaned and sanitized
- Hinged compressor compartment panel for access to clean-out port and condenser coil cleaning
- 6" high legs, adjustable and movable along full length leg rail
- Available up to 16' under one common assembly
- Adapter bars to accommodate a compliment of 1/6 size pans
- Interior lighting inside the base cabinet

REFRIGERATION SYSTEM: All models will utilize state of the art, energy efficient R290 compressor systems with (0) ozone depletion (ODP) and (3) global warming potential (GWP). The pan opening is conductively cooled by coldwall wrapped tank utilizing Randell's exclusive aluminum cold transfer plates to maximum heat removal capacity. Independently controlled pan opening and base temperatures are managed by externally mounted visible electronic controllers metered using capillary tube systems. Independent pan opening control (separate from the base cabinet temperature control) allows the operator precise control of the temperature in each zone and the ability to shut the pan opening off at night for energy savings up to 60% of the daytime usage. Independent base control featuring adaptive defrost allows precise control of the base cabinet.

CABINET EXTERIOR: Top to be one piece of die-formed 16 gauge stainless steel with 2 1/2" nosing with full length plate shelf below. Ends at top fitted with recessed heavy duty steel bars for field bolting units together, producing a hairline seam. Hinged louver panel to be stainless steel. Exterior body to be corrosion resistant steel. Drawer opening frames are ABS and contain magnetic strip for positive seal of drawer gaskets. Work surface to be at 36" work height. Legs to be 6" high stainless steel with adjustable bullet foot. Legs mounted to full length channel frame assembly which is integrally welded to bottom of body assembly. Legs can be moved left to right to avoid floor obstacles during installation.

CABINET INTERIOR: Base interior to be ABS thermoplastic at ends only. Stainless steel interior liner to be coved cornered to form bottom, back and top. Unit insulation to be CFC free foamed in place urethane.

REFRIGERATED DRAWERS: Fully welded, unitized drawer cartridge assembly - patented. Heavy duty full extension 14 gauge drawer tracks on 1-5/8" heavy duty stainless steel bearings. Pans not included. Quick release allows drawers to be easily removed for cleaning. Stainless fronts, mounted to drawer cartridge assembly with easy to grasp drawer handles. Drawers with press fit magnetic gaskets - (designed for installation and removal without tools).



PROJECT NAME:	
LOCATION:	
ITEM NO:	
QTY:	
MODEL NO:	
AIA NO:	
SIS NO:	
CSI SECTION:	11400



Model LPNPO1L257 shown

OPTIONS/ACCESSORIES:

- Cabinet:**
- Remove backsplash
 - Replace drawer set with door (19" & 27" only)
 - Intermediate shelves
 - Adjustable shelves
 - Stainless steel finished back
 - Stainless steel finished ends
 - Laminate fronts, ends and back
 - Casters in lieu of legs
 - Drawer lock(s)
- Pan Opening Covers:**
- Hood cover with slide-back front
 - Lift-off (removable)
 - See-through hinged cover
 - Hinged slide-back cover

- Work-Surface:**
- White poly cutting board, 1/2" or 3/4"
 - Richlite cutting board, 1/2" or 3/4"
 - Wire prep racks (for placement on stainless steel surface)

- Additional Storage:**
- Partial length pan opening
 - Overshelfing storage options

- Voltage:**
- 220-230V/50-60Hz supplied with cord (plug provided in field by others)

ADDITIONAL RESOURCES:

- [Request A Quote](#)
- [Sales Tools](#)
- [Find A Rep](#)
- [KCL AutoCAD/Revit](#)

LPNP01L133

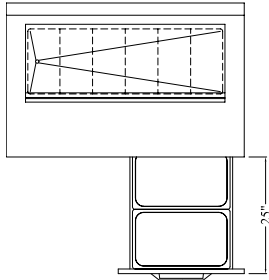

DRAWERS ACCOMMODATE—
(2) 12" X 20" X 4" DEEP PANS
FRONT-BACK PER DRAWER
(PANS NOT PROVIDED)

LPNP01L138

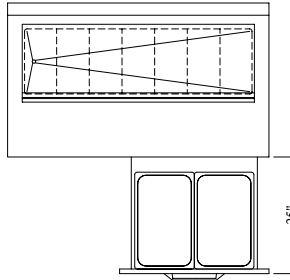

DRAWERS ACCOMMODATE
(2) 12" X 20" X 4" DEEP PANS
SIDE-SIDE PER DRAWER
(PANS NOT PROVIDED)

LPNP01L150

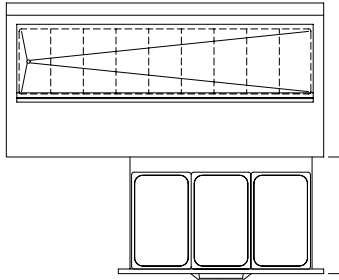

DRAWERS ACCOMMODATE
(3) 12" X 20" X 4" DEEP PANS
SIDE-SIDE PER DRAWER
(PANS NOT PROVIDED)

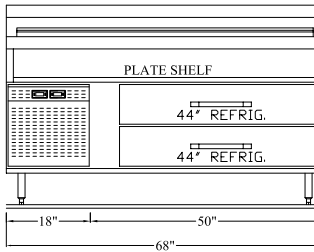
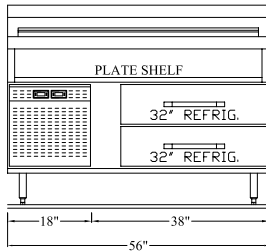
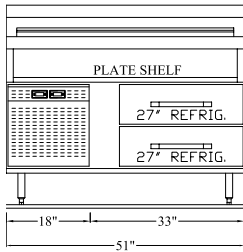

MODEL	COMPRESSOR		BASE SECTION(S)	STANDARD REF. BASE CONFIGURATION	MIN. UNIT LENGTH*	PAN OPENING CAPACITY 1/6 SIZE PAN	BASE STORAGE CUBIC FT/ DRAWER CAPACITY	H.P./ REFRIGERANT	VOLT/ CYCLE/ PHASE	AMPS	NEMA PLUG	SHIP WT.
	QTY/COMP. HSG SIZE	LOCATION "x"										
1 SECTION BASE STORAGE-SELF CONTAINED REFRIGERATORS WITH NARROW DEPTH PAN OPENING												
LPNP01x133	(1)-18" MINIMUM SIZE	R= RIGHT, L=LEFT	1	(1) 27" SET OF DRAWERS, 6" COIL	51	12	(4) 12"x20"x4" DP PANS	1/3-R290	115/60/1	6	5-15P	525
LPNP01x138	(1)-18" MINIMUM SIZE	R= RIGHT, L=LEFT	1	(1) 32" SET OF DRAWERS, 6" COIL	56	14	(4) 12"x20"x4" DP PANS	1/3-R290	115/60/1	6	5-15P	550
LPNP01x150	(1)-18" MINIMUM SIZE	R= RIGHT, L=LEFT	1	(1) 44" SET OF DRAWERS, 6" COIL	68	18	(6) 12"x20"x4" DP PANS	1/3-R290	115/60/1	6	5-15P	585

*Additional length added to compressor housing.

All drawings shown with compressor left (LPNP01L) version of unit; compressor right model (LPNP01R) is mirrored.

LPNP01L249

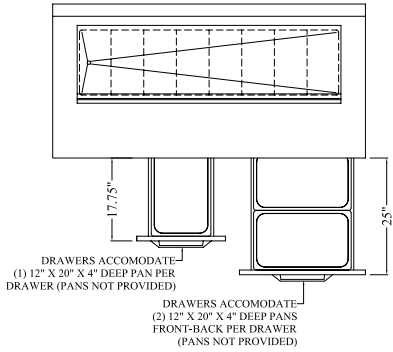

LPNP01L254

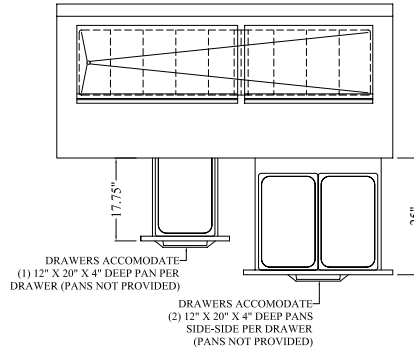

LPNP01L257

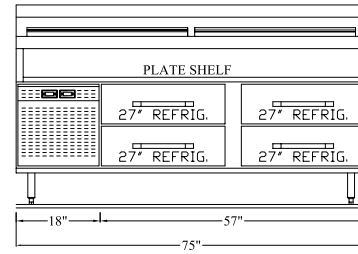
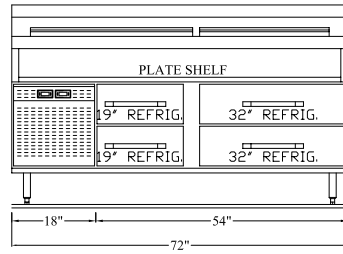
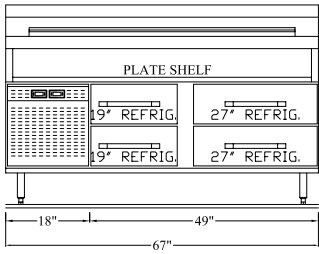
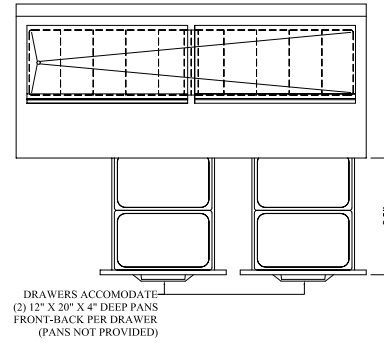

MODEL	COMPRESSOR		BASE SECTION(S)	STANDARD REF. BASE CONFIGURATION	MIN. UNIT LENGTH*	PAN OPENING CAPACITY 1/6 SIZE PAN	BASE STORAGE CUBIC FT/ DRAWER CAPACITY	H.P./ REFRIGERANT	VOLT/ CYCLE/ PHASE	AMPS	NEMA PLUG	SHIP WT.
	QTY/COMP. HSG SIZE	LOCATION "x"										
2 SECTION BASE STORAGE-SELF CONTAINED REFRIGERATORS WITH NARROW DEPTH PAN OPENING												
LPNP01x249	(1)-18" MINIMUM SIZE	R= RIGHT, L=LEFT	2	(1) 19" SET OF DRAWERS + (1) 27" SET OF DRAWERS	67	16	(6) 12"x20"x4" DP PANS	1/3-R290	115/60/1	6	5-15P	605
LPNP01x254	(1)-18" MINIMUM SIZE	R= RIGHT, L=LEFT	2	(1) 19" SET OF DRAWERS + (1) 32" SET OF DRAWERS	72	18	(6) 12"x20"x4" DP PANS	1/3-R290	115/60/1	6	5-15P	635
LPNP01x257	(1)-18" MINIMUM SIZE	R= RIGHT, L=LEFT	2	(2) 27" SETS OF DRAWERS	75	20	(8) 12"x20"x4" DP PANS	1/3-R290	115/60/1	6	5-15P	660

*Additional length added to compressor housing.

All drawings shown with compressor left (LPNP01L) version of unit; compressor right model (LPNP01R) is mirrored.

DIMENSIONAL DETAIL:

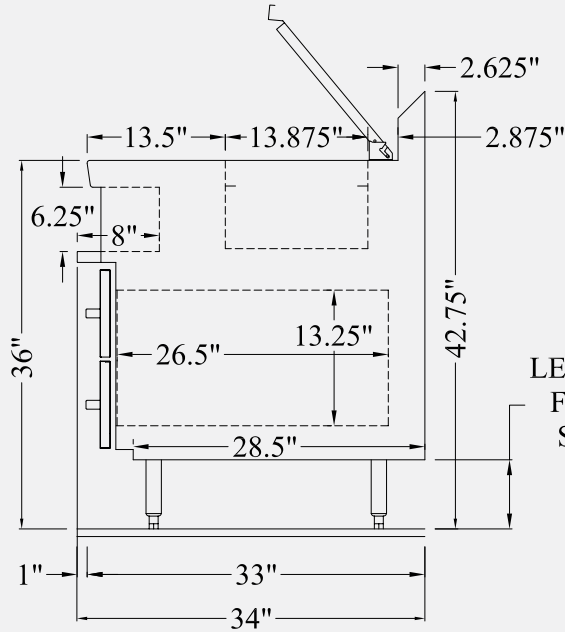

LEGS ADJUSTABLE
FROM: 6" - 7.125"
SHOWN @ 6.75"

Stainless Steel Finished End:

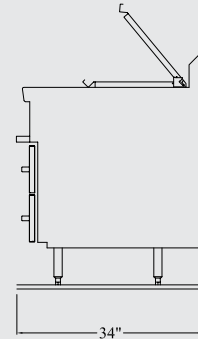

Unfinished End:

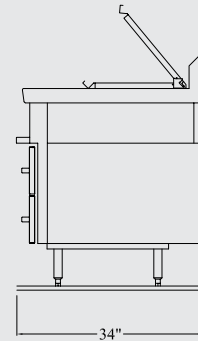

OPTIONAL COVERS:

Hinged Cover (standard):

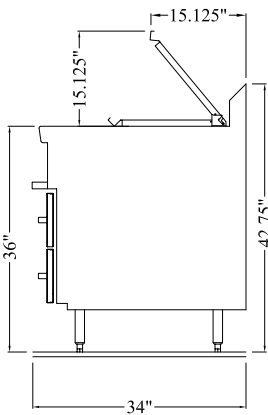

Hinged Slide-Back Cover:

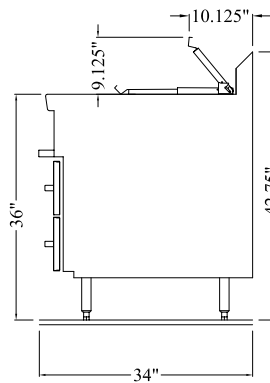

Lift-Off Cover:

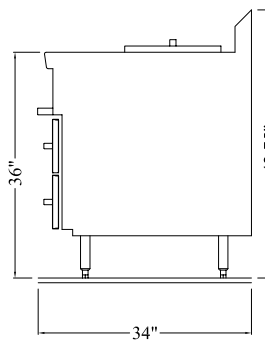

Hood Cover:

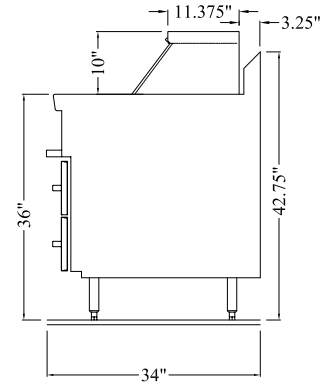

*Units shown with optional stainless steel end panels.