



# PREP STATIONS

## SPECIALTY CUSTOM FLAT CONDIMENT WIDE OPENING MODELS 5300LPWPO

Remote "low profile" drawer base refrigerator storage unit with drawers and a mechanically cooled pan opening. Cold-wall conductive cooled pan opening with recessed pan ledge provides easy reach and cold above pans for optimal temperatures. Separate base and pan opening controllers give the operator precise control of the temperature in each zone and the ability to shut the pan opening off at night. Standard clean-out port allows pan opening to be easily cleaned and sanitized.

**SHORT FORM SPEC:** Randell 5300LPWPO series preparation table with remote refrigeration system. Includes independently controlled mechanically cooled pan opening and refrigerated base, each controlled by their own mechanical control. Single pan opening to come standard with recessed pan ledge, adapter bars and oversized clean-out port for ease of cleanability. Base interior ends and drawer openings shall be high impact ABS plastic with coved corner stainless steel interior to form bottom, back and top of cabinet and be cooled with a blower coil located behind the mullion. Base cabinet standard with heavy-duty cartridge style drawers with press-fit magnetic gaskets. Unit to be shipped standard on adjustable legs mounted to full length leg rails. cUL, UL, NSF.

### AVAILABLE MODELS:

#### 1 Section:

- 53330LPWPO
- 53338LPWPO
- 53343LPWPO

#### 2 Sections:

- 53355LPWPO
- 53360LPWPO
- 53363LPWPO
- 53368LPWPO
- 53373LPWPO

#### 3 Sections:

- 53385LPWPO

### STANDARD FEATURES:

- Cold-wall conductive cooled pan opening with recessed pan ledge for easy reach and cold above pans
- Base cooled by high capacity mullion coil refrigeration system with automatic defrost
- Filter dryer installed on each liquid line
- Independent temp control for pan opening and base allows precise temperature maintenance in each zone
- Drawer cartridge system with easy maintenance press-fit gaskets (removable without tools)
- Exclusive completely sealed pan opening interior with clean-out port allows pan opening to be easily cleaned and sanitized
- Hinged mechanical compartment panel for access to clean-out port
- 6" high legs, adjustable and movable along full length leg rail
- Available up to 16' under one common assembly
- Adapter bars to accommodate a compliment of 1/6 size pans
- Interior lighting inside the base cabinet

**REFRIGERATION SYSTEM:** Refrigerant to be specified by customer (Specification based on R-448a refrigerant). The base and pan opening are thermostatically controlled operating on independent solenoid and expansion valves. (located in the mechanical housing at the rear of the unit) The pan opening is conductively cooled by coldwall wrapped tank utilizing Randell's exclusive aluminum cold transfer plates to maximum heat removal

capacity. An on/off switch for the pan opening is provided. Interior fitted with Randell evaporator blower coil for cooling base. Condensing unit not provided. Unit prewired to junction box for 115V operation. Electric condensate evaporator is optional.

**CABINET EXTERIOR:** Top to be one piece of die-formed 16 gauge stainless steel with 2 1/2" nosing with full length plate shelf below. Ends at top fitted with recessed heavy duty steel bars for field bolting units together, producing a hairline seam. Hinged panel to be stainless steel. Exterior body to be corrosion resistant steel. Drawer opening frames are ABS and contain magnetic strip for positive seal of drawer gaskets. Work surface to be at 36" work height. Legs to be 6" high stainless steel with adjustable bullet foot. Legs mounted to full length channel frame assembly which is integrally welded to bottom of body assembly. Legs can be moved left to right to avoid floor obstacles during installation.

**CABINET INTERIOR:** Base interior to be ABS thermoplastic at ends only. Stainless steel interior liner to be coved cornered to form bottom, back and top. Unit insulation to be CFC free foamed in place urethane.

**REFRIGERATED DRAWERS:** Fully welded, unitized drawer cartridge assembly - patented. Heavy duty full extension 14 gauge drawer tracks on 1-5/8" heavy duty stainless steel bearings. Pans not included. Quick release allows drawers to be easily removed for cleaning. Stainless fronts, mounted to drawer cartridge assembly with easy to grasp drawer handles. Drawers with press fit magnetic gaskets - (designed for installation and removal without tools).



PROJECT NAME:	
LOCATION:	
ITEM NO:	
QTY:	
MODEL NO:	
AIA NO:	
SIS NO:	
CSI SECTION:	11400



Model 53360LPWPO shown

### OPTIONS/ACCESSORIES:

#### Cabinet:

- Remove backsplash
- Replace drawer set with door (19" & 27" only)
- Intermediate shelves
- Adjustable shelves
- Stainless steel finished back
- Stainless steel finished ends
- Laminate fronts, ends and back
- Electric condensate evaporator
- Drawer lock(s)

#### Pan Opening Covers:

- Hood cover with slide-back front
- Lift-off (removable)

#### Work-Surface:

- White poly cutting board, 1/2" or 3/4"
- Richlite cutting board, 1/2" or 3/4"

#### Additional Storage:

- Partial length pan opening
- Overshelfing storage options

### ADDITIONAL RESOURCES:

- [Request A Quote](#)
- [Sales Tools](#)
- [Find A Rep](#)
- [KCL AutoCAD/Revit](#)

53330LPWPO

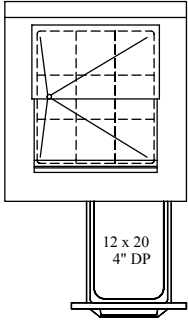

53338LPWPO

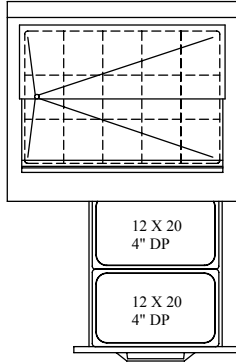

53343LPWPO

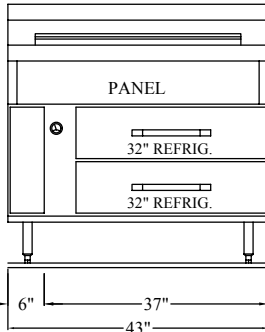
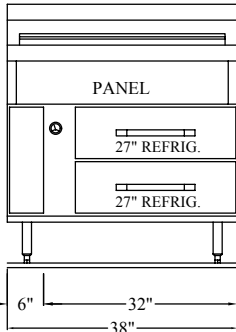
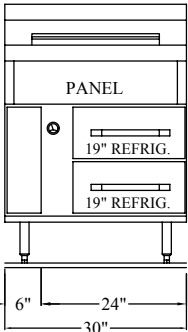
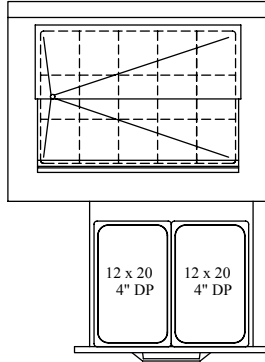

MODEL	LENGTH (IN)	DEPTH (IN)	HEIGHT (IN)	TOP-PAN OPENING CAPACITY 1/6 SIZE PAN	BASE-DRAWER SET CONFIGURATION	TOTAL DRAWER PAN CAPACITY	VOLT/ CYCLE/ PHASE	AMPS	BTU LOAD (-10) PAN OPENING, (+20F)BASE	EVAP. BTU/TD** OPENING/ BASE	SHIP WT.
<b>1 SECTION BASE STORAGE-REMOTE REFRIGERATORS WITH NARROW DEPTH PAN OPENING</b>											
<b>53330LPWPO</b>	30	33	42.75	9	(1) SET 19"	(2) 12x20x4	115/60/1	5	340/446	16/120	391
<b>53338LPWPO</b>	38	33	42.75	15	(1) SET 27"	(4) 12x20x4	115/60/1	5	567/563	23/120	422
<b>53343LPWPO</b>	43	33	42.75	15	(1) SET 32"	(4) 12x20x4	115/60/1	5	567/636	23/120	463

NOTES: \*BTU loads shown are based on 100° ambient plus 30% for usage and product loading in base. Final system selection should consider usage requirements and combined loads. \*\*Evaporator BTU/\*\*TD reflects NSF refrigerated base requirements when base is provided with +20° F system separate from -10°F pan opening system. \*\*\*Additional length added to mechanical housing

53355LPWPO

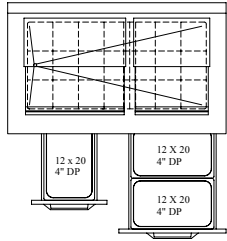

53360LPWPO

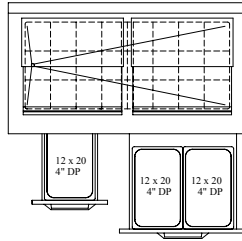

53363LPWPO

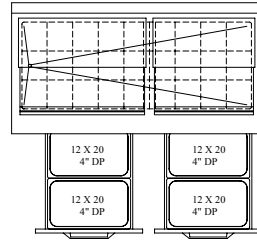

53368LPWPO

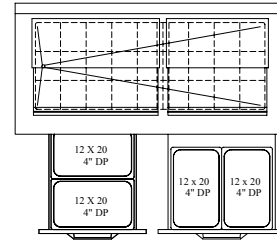

53373LPWPO

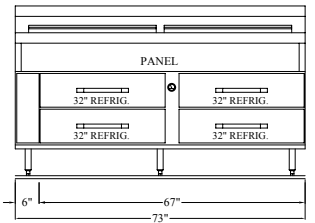
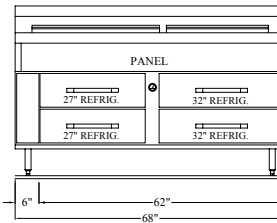
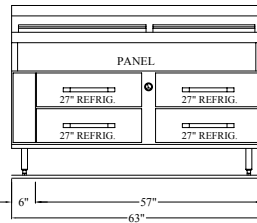
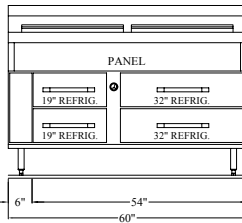
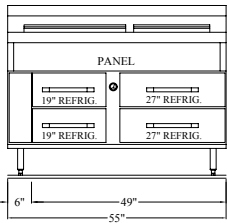
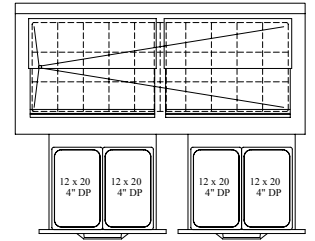

53385LPWPO

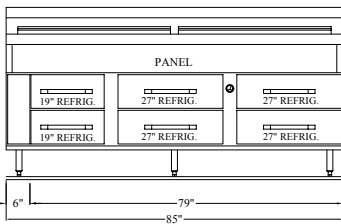
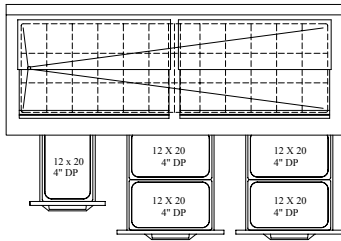

MODEL	LENGTH (IN)	DEPTH (IN)	HEIGHT (IN)	TOP-PAN OPENING CAPACITY 1/6 SIZE PAN	BASE-DRAWER SET CONFIGURATION	TOTAL DRAWER PAN CAPACITY	VOLT/ CYCLE/ PHASE	AMPS	BTU LOAD (-10) PAN OPENING, (+20F)BASE	EVAP. BTU/TD** OPENING/ BASE	SHIP WT.
<b>2 SECTION BASE STORAGE-REMOTE REFRIGERATORS WITH NARROW DEPTH PAN OPENING</b>											
53355LPWPO	55	33	42.75	21	(1) SET 19", (1) SET 27"	(6) 12x20x4	115/60/1	5	680/791	27/120	524
53360LPWPO	60	33	42.75	24	(1) SET 19", (1) SET 32"	(6) 12x20x4	115/60/1	5	907/996	34/120	571
53363LPWPO	63	33	42.75	27	(2) SETS 27"	(8) 12x20x4	115/60/1	5	1021/1040	37/120	587
53368LPWPO	68	33	42.75	27	(1) SET 27", (1) SET 32"	(8) 12x20x4	115/60/1	5	1021/1113	37/120	602
53373LPWPO	73	33	42.75	30	(2) SETS 32"	(8) 12x20x4	115/60/1	5	1134/1186	41/120	617
<b>3 SECTION BASE STORAGE-REMOTE REFRIGERATORS WITH NARROW DEPTH PAN OPENING</b>											
53385LPWPO	85	33	42.75	36	(1) SET 19", (2) SETS 27"	(10) 12x20x4	115/60/1	5	1361/1472	48/120	717

NOTES: \*BTU loads shown are based on 100° ambient plus 30% for usage and product loading in base. Final system selection should consider usage requirements and combined loads. \*\*Evaporator BTU/TD reflects NSF refrigerated base requirements when base is provided with +20° F system separate from -10°F pan opening system. \*\*\*Additional length added to mechanical housing

**DIMENSIONAL DETAIL:**

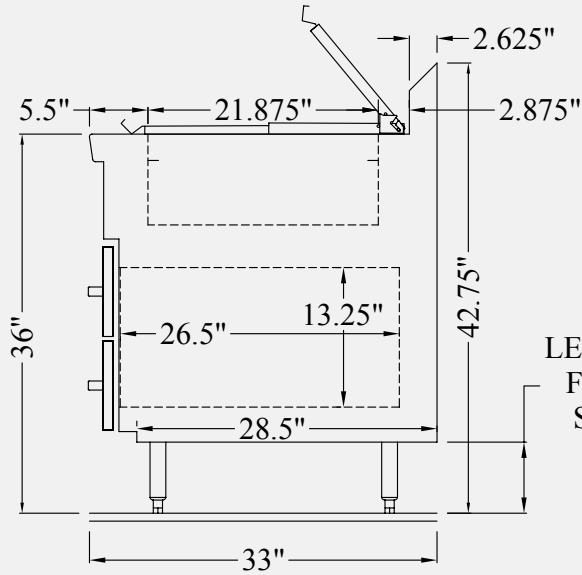

LEGS ADJUSTABLE  
FROM: 6" - 7.125"  
SHOWN @ 6.75"

Stainless Steel Finished End:

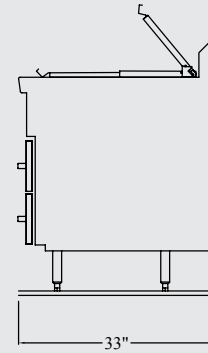

Unfinished End:

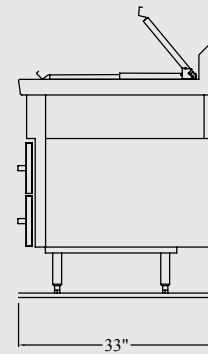

**OPTIONAL COVERS:**

Hinged Slide-Back Cover (standard):

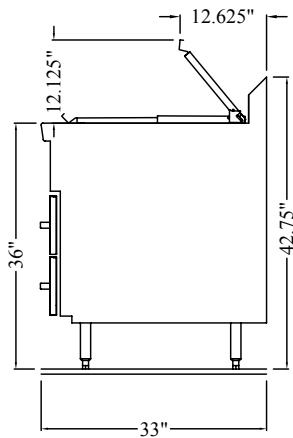

Lift-Off Cover:

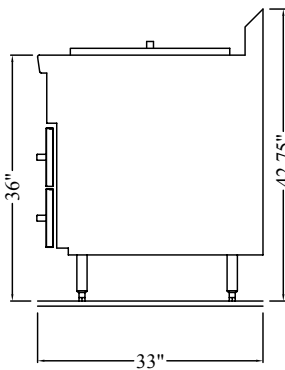

Hood Cover:

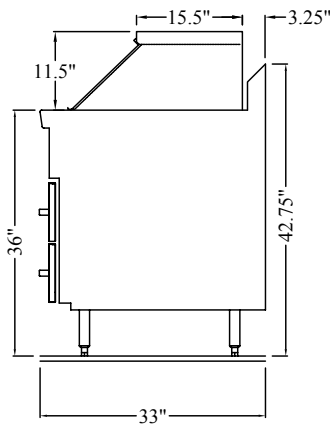

\*Units shown with optional stainless steel end panels.